

8S648FXP-RZ / 8S648FXP-RZ-C

Intel® Pentium® 4 Processor Motherboard

User's Manual

Rev. 1001

12ME-S648FXPRZ-1001

Copyright

© 2004 GIGABYTE TECHNOLOGY CO., LTD

Copyright by **GIGA-BYTE TECHNOLOGY CO., LTD. ("GBT")**. No part of this manual may be reproduced or transmitted in any form without the expressed, written permission of **GBT**.

Trademarks

Third-party brands and names are the property of their respective owners.

Notice

Please do not remove any labels on motherboard, this may void the warranty of this motherboard.

Due to rapid change in technology, some of the specifications might be out of date before publication of this booklet.

The author assumes no responsibility for any errors or omissions that may appear in this document nor does the author make a commitment to update the information contained herein.

Declaration of Conformity

(Not for full access)

G.B.T. Technology Trading GmbH
Anschlagger Weg 41, P-20371 Tammung, Germany

(description of the apparatus, system, installation to which it refers)

Mother Board

8S648F-XP-RZ

(reference to the specification under which conformity is declared)
is in conformity with
in accordance with 89/392 EEC-EMC Directive

- | | | | |
|--|---|---|--|
| <input type="checkbox"/> EN 55011 | Limits and methods of measurement of radio disturbance characteristics of industrial, scientific and medical (ISM) high frequency equipment | <input checked="" type="checkbox"/> EN 61000-3-2 | Disturbances in supply systems caused by industrial and similar systems caused by household and similar apparatus "Voltage fluctuations" |
| <input type="checkbox"/> EN 55013 | Limits and methods of measurement of radio disturbance characteristics of broadcast receivers and associated equipment | <input checked="" type="checkbox"/> EN 55024 | Information technology equipment immunity requirements characteristics: Limits and methods of measurement |
| <input type="checkbox"/> EN 55014-1 | Limits and methods of measurement of radio disturbance characteristics of portable tools and similar electrical apparatus | <input type="checkbox"/> EN 50082-1 | Generic immunity standard Part 1: Residential, commercial and light industry |
| <input type="checkbox"/> EN 55015 | Limits and methods of measurement of radio disturbance characteristics of television sets and tuners | <input type="checkbox"/> EN 50082-2 | Generic immunity standard Part 2: Industrial environment |
| <input type="checkbox"/> EN 55020 | Immunity from radio interference of broadcast receivers and associated equipment | <input type="checkbox"/> EN 55014-2 | Immunity requirements for household appliances tools and similar apparatus |
| <input checked="" type="checkbox"/> EN 55022 | Limits and methods of measurement of radio disturbance characteristics of information technology equipment | <input type="checkbox"/> EN 50081-2 | EMC requirements for unremovable power systems (UPS) |
| <input type="checkbox"/> DIN VDE 0885 Part 10 | Cable distribution systems: Equipment for receiving and/or distribution from sound and television signals | | |
| <input type="checkbox"/> Part 12 | | | |
| <input checked="" type="checkbox"/> CE marking | |  | (EC conformity marking) |
- The manufacturer also declares the conformity of those mentioned product with the actual required safety standards in accordance with LVD 7323 EEC**
- | | | | |
|-----------------------------------|---|-------------------------------------|---|
| <input type="checkbox"/> EN 60085 | Safety requirements for mains operated electronic and related apparatus for household and similar general use | <input type="checkbox"/> EN 60980 | Safety for information technology equipment including electrical business equipment |
| <input type="checkbox"/> EN 60335 | Safety of household and similar electrical appliances | <input type="checkbox"/> EN 50081-1 | General and Safety requirements for unremovable power systems (UPS) |

Manufacturer/Importer

Signature: Jimmy Huang

(Stamp)

Date: Nov. 3, 2004

Name: Timmy Huang

DECLARATION OF CONFORMITY

Per FCC Part 2 Section 2.1077(a)



Responsible Party Name: G.B.T. INC. (U.S.A.)

Address: 17358 Railroad Street

City of Industry, CA 91748

Phone/Fax No: (818) 854-9338/ (818) 854-9339

hereby declares that the product

Product Name: Motherboard

Model Number: 8S648F-XP-RZ

conforms to the following specifications:

FCC Part 15, Subpart B, Section 15.107(a) and Section 15.109

(a), Class B Digital Device

Supplementary Information:

This device complies with part 15 of the FCC Rules. Operation is subject to the following two conditions: (1) This device may not cause harmful and (2) this device must accept any interference received, including that may cause undesired operation.

Representative Person's Name: ERIC LU

Signature: Eric Lu

Date: Nov. 3, 2004

Preparing Your Computer

Computer motherboards and expansion cards contain very delicate Integrated Circuit (IC) chips. To protect them against damage from static electricity, you should follow some precautions whenever you work on your computer.

1. Unplug your computer when working on the inside.
2. Use a grounded wrist strap before handling computer components. If you do not have one, touch both of your hands to a safely grounded object or to a metal object, such as the power supply case.
3. Hold components by the edges and try not touch the IC chips, leads or connectors, or other components.
4. Place components on a grounded antistatic pad or on the bag that came with the components whenever the components are separated from the system.
5. Ensure that the ATX power supply is switched off before you plug in or remove the ATX power connector on the motherboard.



Installing the motherboard to the chassis

If the motherboard has mounting holes, but they don't line up with the holes on the base and there are no slots to attach the spacers, do not become alarmed you can still attach the spacers to the mounting holes. Just cut the bottom portion of the spacers (the spacer may be a little hard to cut off, so be careful of your hands). In this way you can still attach the motherboard to the base without worrying about short circuits. Sometimes you may need to use the plastic springs to isolate the screw from the motherboard PCB surface, because the circuit wire may be near by the hole. Be careful, don't let the screw contact any printed circuit write or parts on the PCB that are near the fixing hole, otherwise it may damage the board or cause board malfunctioning.

Table of Contents

Chapter 1 Introduction	5
Features Summary	5
8S648FXP-RZ Series Motherboard Layout	6
Block Diagram	7
Hardware Installation Process	8
Step 1: Install the Central Processing Unit (CPU)	8
Step 1-1: CPU Installation	9
Step 1-2: CPU Cooling Fan Installation	9
Step 2: Install Memory Modules	10
Step 3: Install AGP Card	11
Step 4: Install I/O Peripherals Cables	11
Step 4-1: I/O Back Panel Introduction	11
Step 4-2: Connectors Introduction	12
Chapter 2 BIOS Setup	19
The Main Menu (For example: BIOS Ver. : E10)	19
Standard CMOS Features	21
Advanced BIOS Features	23
Integrated Peripherals	25
Power Management Setup	27
PnP/PCI Configurations	29
PC Health Status	30
MB Intelligent Tweaker(M.I.T.)	31
Top Performance	32
Load Fail-Safe Defaults	33
Load Optimized Defaults	33
Set Supervisor/User Password	34
Save & Exit Setup	35
Exit Without Saving	35
Chapter 3 Install Drivers	37

Chapter 1 Introduction

Features Summary

Motherboard	<ul style="list-style-type: none"> 8S648FXP-RZ or 8S648FXP-RZ-C
CPU	<ul style="list-style-type: none"> Socket 478 for Intel® Pentium® 4 (Northwood, Prescott) with HT Technology Intel® Pentium® 4 800/533/400MHz FSB 2nd cache depends on CPU
Chipset	<ul style="list-style-type: none"> Northbridge : SiS 648FX Southbridge : SiS 964
Memory	<ul style="list-style-type: none"> 3 184-pin DDR DIMM sockets, supports up to 3GB DRAM (Max) Supports DDR400/DDR333/DDR266 DIMM Supports up to 2 unbuffered DIMM DDR400 Supports up to 3 unbuffered DIMM DDR333 Supports only 2.5V DDR SDRAM
Slots	<ul style="list-style-type: none"> 1 AGP slot supports 8X/4X(1.5V) mode 5 PCI slots
IDE Connections	<ul style="list-style-type: none"> 2 IDE connections (Ultra DMA33/ATA66/ATA100/ATA133), allows connection of 4 IDE devices
FDD Connections	<ul style="list-style-type: none"> 1 FDD connection, allows connection of 2 FDD devices
Onboard SATA	<ul style="list-style-type: none"> 2 Serial ATA ports from SiS 964 (SATA0, SATA1)
Peripherals	<ul style="list-style-type: none"> 1 Parallel port supporting Normal/EPP/ECP mode 2 Serial port (COMA, COMB) 8 USB 2.0/1.1 ports (rear x 4, front x 4 via cable) 1 front audio connector 1 PS/2 keyboard port 1 PS/2 mouse port
Onboard LAN*	<ul style="list-style-type: none"> Onboard ICS1883 chipset (10/100Mbit)* 1 RJ45 port*
Onboard Audio	<ul style="list-style-type: none"> ALC655 codec Supports 2/ 4/ 6 channel audio Line Out/ Line In/ Mic In connection SPDIF In/ Out CD In connector
I/O Control	<ul style="list-style-type: none"> IT8705
Hardware Monitor	<ul style="list-style-type: none"> System voltage detection CPU temperature detection CPU / System fan speed detection
Onboard SATA RAID	<ul style="list-style-type: none"> Onboard SiS 964 chipset (SATA0, SATA1) Supports data striping (RAID 0) or mirroring (RAID 1) function Supports data transfer rate of up 150MB Supports a maximum of 2 SATA connections
BIOS	<ul style="list-style-type: none"> Use of licensed AWARD BIOS Supports Q-Flash
Additional Features	<ul style="list-style-type: none"> Supports @BIOS Supports EasyTune
Form Factor	<ul style="list-style-type: none"> ATX form factor, 21cm x 29.5cm

* ** Only for 8S648FXP-RZ.

8S648FXP-RZ Series Motherboard Layout

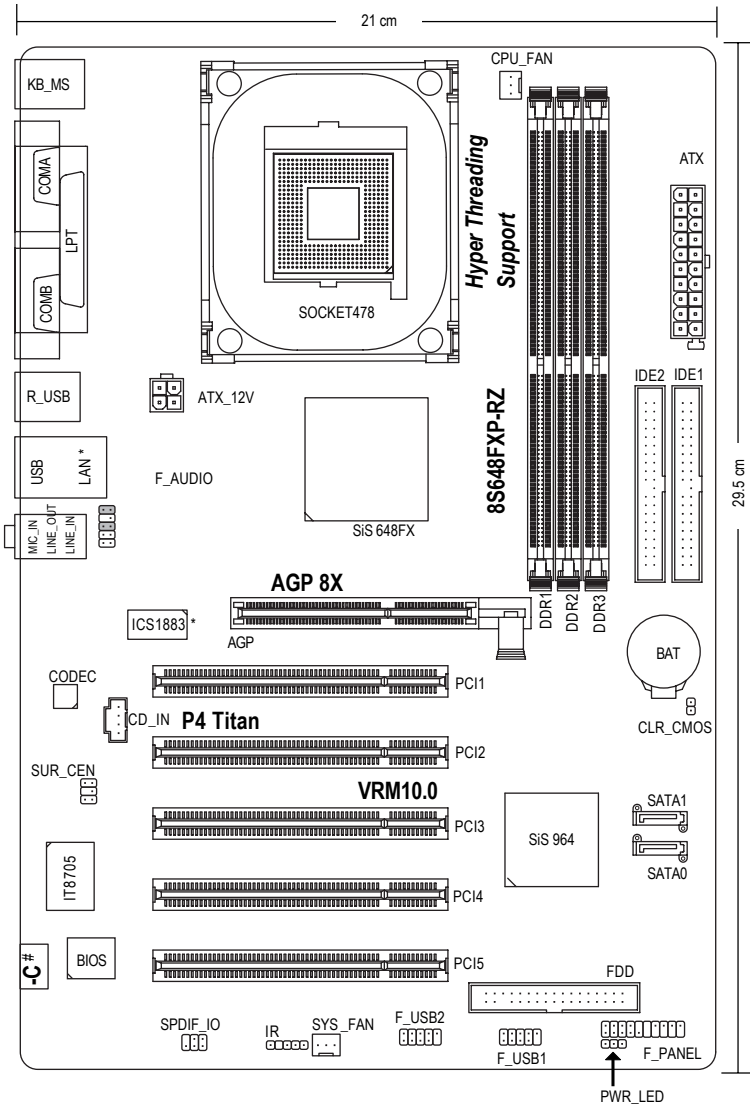

*** Only for 8S648FXP-RZ.
 # Only for 8S648FXP-RZ-C.

Block Diagram

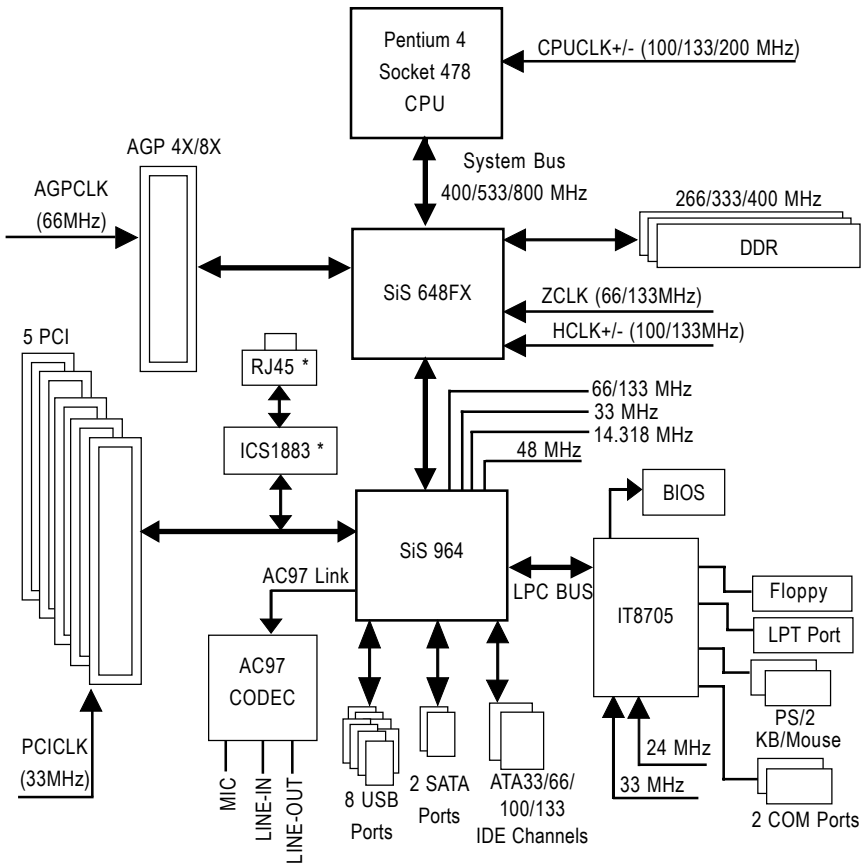

*** Only for 8S648FXP-RZ.

Hardware Installation Process

To set up your computer, you must complete the following steps:

- Step 1- Install the Central Processing Unit (CPU)
- Step 2- Install memory modules
- Step 3- Install expansion cards
- Step 4- Install I/O Peripherals Cables

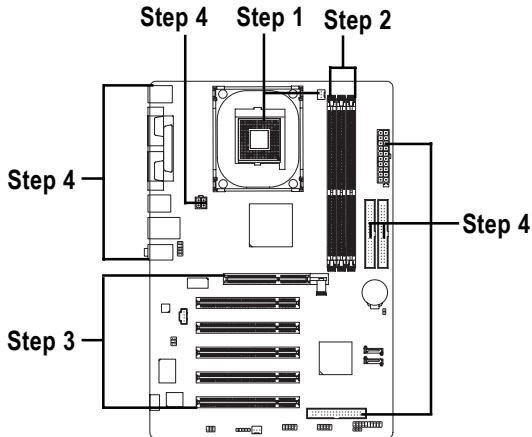

Step 1: Install the Central Processing Unit (CPU)



CAUTION

Before installing the processor, adhere to the following warning:

1. Please make sure the CPU type is supported by the motherboard.
2. The processor will overheat without the heatsink and/or fan, resulting in permanent irreparable damage.
3. If you do not match the CPU socket Pin 1 and CPU cut edge well, it will cause improper installation. Please change the insert orientation.
4. Apply thermal grease between the processor and cooling fan.
5. Never run the processor without the heatsink properly and firmly attached. Permanent damage will result.
6. Please set the CPU host frequency in accordance with your processor's specifications. We don't recommend you to set the system bus frequency over the CPU's specification because these specific bus frequencies are not the standard specifications for CPU, chipset and most of the peripherals. Whether your system can run under these specific bus frequencies properly will depend on your hardware configurations, including CPU, Memory, Cards...etc.



NOTE

HT functionality requirement content :

Enabling the functionality of Hyper-Threading Technology for your computer system requires all of the following platform components:

- CPU: An Intel® Pentium 4 Processor with HT Technology
- Chipset: A SiS® Chipset that supports HT Technology
- BIOS: A BIOS that supports HT Technology and has it enabled
- OS: An operation system that has optimizations for HT Technology

Step 1-1: CPU Installation

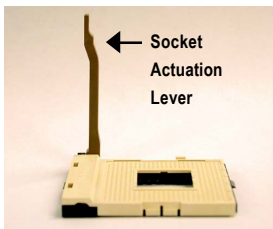

Figure 1.
Pull the rod to the 90-degree directly.

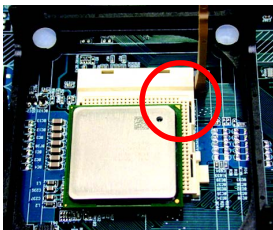

Figure 2.
Locate Pin 1 in the socket and look for a (golden) cut edge on the CPU upper corner. Insert the CPU into the socket. (Do not force the CPU into the socket.) Then move the socket lever to the locked position while holding pressure on the center of the CPU.

Step 1-2: CPU Cooling Fan Installation



Figure 1.
Apply the thermal tape(or grease) to provide better heat conduction between your CPU and cooling fan.



Figure 2.
Fasten the cooling fan supporting-base onto the CPU socket on the motherboard.

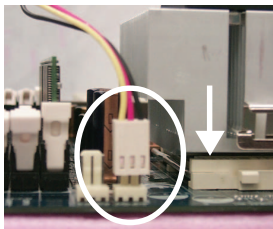

Figure 3.
Make sure the CPU fan is plugged to the CPU fan connector, than install complete.

Step 2: Install Memory Modules



Before installing the memory modules, please comply with the following conditions:

1. Please make sure that the memory used is supported by the motherboard. It is recommended that memory of similar capacity, specifications and brand be used.
2. Before installing or removing memory modules, please make sure that the computer power is switched off to prevent hardware damage.
3. Memory modules have a foolproof insertion design. A memory module can be installed in only one direction. If you are unable to insert the module, please switch the direction.

The motherboard supports DDR memory modules, whereby BIOS will automatically detect memory capacity and specifications. Memory modules are designed so that they can be inserted only in one direction. The memory capacity used can differ with each slot.

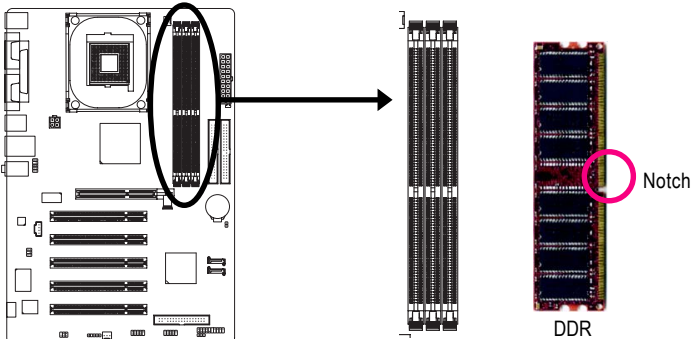

1. The DIMM socket has a notch, so the DIMM memory module can only fit in one direction.

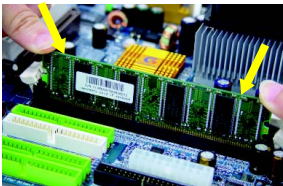

2. Insert the DIMM memory module vertically into the DIMM socket. Then push it down.



3. Close the plastic clip at both edges of the DIMM sockets to lock the DIMM module.
Reverse the installation steps when you wish to remove the DIMM module.

Step 3: Install AGP Card

1. Read the relate AGP card's instruction document before install the AGP card into the computer.
2. If your AGP card has "AGP 4X/8X(1.5V) notch"(show below), please make sure your AGP card is AGP 4X/8X(1.5V).



3. Please carefully pull out the small white-drawable bar at the end of the AGP slot when you try to install/uninstall the AGP card. Please align the AGP card to the onboard AGP slot and press firmly down on the slot. Make sure your AGP card is locked by the small white-drawable bar.

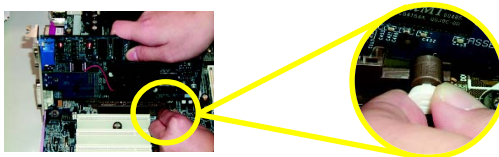

Step 4: Install I/O Peripherals Cables

Step 4-1: I/O Back Panel Introduction

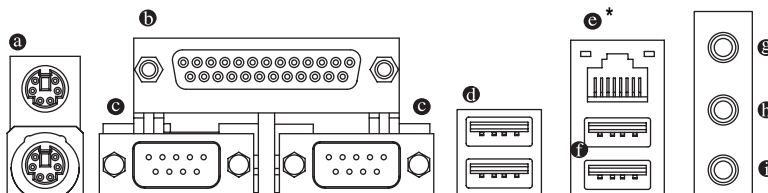

ⓐ PS/2 Keyboard and PS/2 Mouse connector

To install a PS/2 port keyboard and mouse, plug the mouse to the upper port (green) and the keyboard to the lower port (purple).

ⓑ Parallel port (LPT)

The parallel port allows connection of a printer, scanner and other peripheral devices.

ⓒ Serial port (COMA/COMB)

Mouse and modem etc. can be connected to Serial port.

ⓓ USB port

Before you connect your device(s) into USB connector(s), please make sure your device(s) such as USB keyboard, mouse, scanner, zip, speaker...etc. Have a standard USB interface. Also make sure your OS supports USB controller. If your OS does not support USB controller, please contact OS vendor for possible patch or driver upgrade. For more information please contact your OS or device(s) vendors.

*** Only for 8S648FXP-RZ.

④ **LAN port ***

The provided Internet connection is fast Ethernet, providing data transfer speeds of 10/100Mbps.

⑤ **Line In jack**

Devices like CD-ROM, walkman etc. can be connected to Line In jack.

⑥ **Line Out jack**

Connect the stereo speakers or earphone to this connector.

⑦ **MIC In jack**

Microphone can be connect to MIC In jack.

Step 4-2: Connectors Introduction

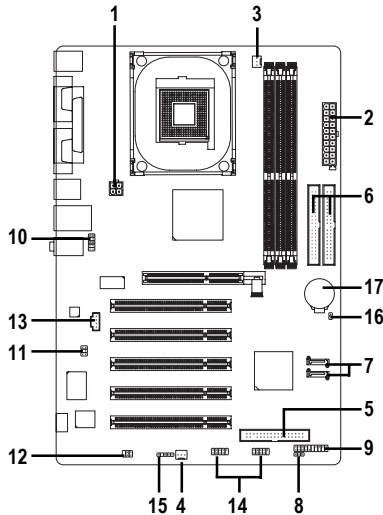

1) ATX_12V	10) F_AUDIO
2) ATX	11) SPDIF_IO
3) CPU_FAN	12) SUR_GEN
4) SYS_FAN	13) CD_IN
5) FDD	14) F_USB1 / F_USB2
6) IDE1 / IDE2	15) IR
7) SATA0 / SATA1	16) CLR_CMOS
8) PWR_LED	17) BAT
9) F_PANEL	

*** Only for 8S648FXP-RZ.

1/2) ATX_12V / ATX (Power Connector)

With the use of the power connector, the power supply can supply enough stable power to all the components on the motherboard. Before connecting the power connector, please make sure that all components and devices are properly installed. Align the power connector with its proper location on the motherboard and connect tightly. The ATX_12V power connector mainly supplies power to the CPU. If the ATX_12V power connector is not connected, the system will not start. **Caution!** Please use a power supply that is able to handle the system voltage requirements. It is recommended that a power supply that can withstand high power consumption be used (300W or greater). If a power supply is used that does not provide the required power, the result can lead to an unstable system or a system that is unable to start.

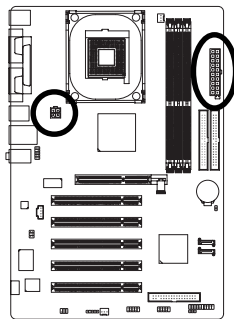

Pin No.	Definition
1	GND
2	GND
3	+12V
4	+12V

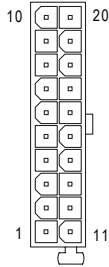

Pin No.	Definition	Pin No.	Definition
1	3.3V	11	3.3V
2	3.3V	12	-12V
3	GND	13	GND
4	VCC	14	PS_ON(soft on/off)
5	GND	15	GND
6	VCC	16	GND
7	GND	17	GND
8	Power Good	18	-5V
9	5V SB (stand by +5V)	19	VCC
10	+12V	20	VCC

3/4) CPU_FAN / SYS_FAN (Cooler Fan Power Connector)

The cooler fan power connector supplies a +12V power voltage via a 3-pin power connector and possesses a foolproof connection design. Most coolers are designed with color-coded power connector wires. A red power connector wire indicates a positive connection and requires a +12V power voltage. The black connector wire is the ground wire (GND).

Caution!

Please remember to connect the power to the CPU fan to prevent CPU overheating and failure.

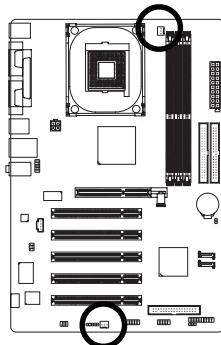

CPU_FAN



SYS_FAN

Pin No.	Definition
1	GND
2	+12V
3	Sense

5) FDD (FDD Connector)

The FDD connector is used to connect the FDD cable while the other end of the cable connects to the FDD drive. The types of FDD drives supported are: 360KB, 720KB, 1.2MB, 1.44MB and 2.88MB. Please connect the red power connector wire to the pin1 position.

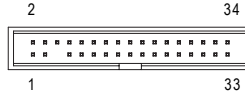
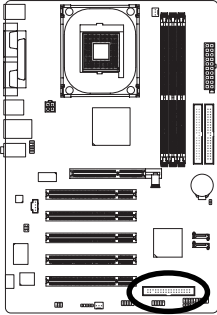

6) IDE1 / IDE2 (IDE1 / IDE2 Connector)

An IDE device connects to the computer via an IDE connector. One IDE connector can connect to one IDE cable, and the single IDE cable can then connect to two IDE devices (hard drive or optical drive). If you wish to connect two IDE devices, please set the jumper on one IDE device as Master and the other as Slave (for information on settings, please refer to the instructions located on the IDE device).

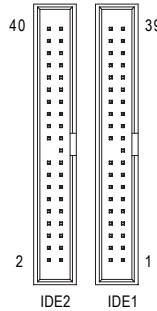
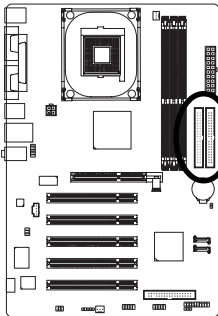

7) SATA0 / SATA1 (Serial ATA Connector)

Serial ATA can provide 150MB/s transfer rate. Please refer to the BIOS setting for the Serial ATA and install the proper driver in order to work properly.

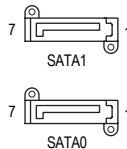
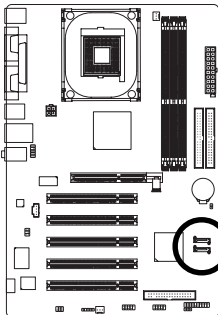

Pin No.	Definition
1	GND
2	TXP
3	TXN
4	GND
5	RXN
6	RXP
7	GND



NOTE For more detailed Serial ATA RAID setup information, please visit our website at <http://www.gigabyte.com.tw>.

8) PWR_LED

PWR_LED is connect with the system power indicator to indicate whether the system is on/off. It will blink when the system enters suspend mode.

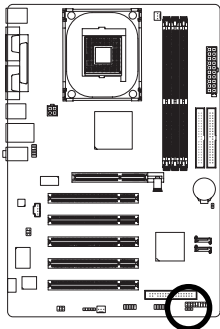

Pin No.	Definition
1	MPD+
2	MPD-
3	MPD-

9) F_PANEL (2 x 10 pins Connector)

Please connect the power LED, PC speaker, reset switch and power switch etc. of your chassis front panel to the F_PANEL connector according to the pin assignment below.

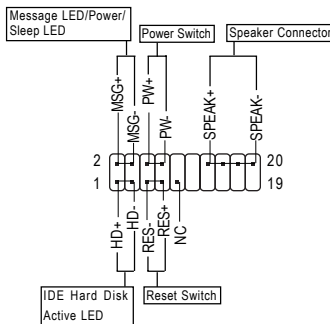
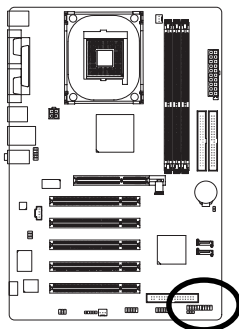

MSG (Message LED/ Power/ Sleep LED)	Pin 1: LED anode(+) Pin 2: LED cathode(-)
PW (Power Switch)	Open: Normal Operation Close: Power On/Off
SPK (Speaker Connector)	Pin 1: VCC(+) Pin 2- Pin 3: NC Pin 4: Data(-)
HD (IDE Hard Disk Active LED)	Pin 1: LED anode(+) Pin 2: LED cathode(-)
RES (Reset Switch)	Open: Normal Operation Close: Reset Hardware System
NC	NC

10) F_AUDIO (Front Audio Connector)

If you want to use Front Audio connector, you must remove 5-6, 9-10 Jumper.

In order to utilize the front audio header, your chassis must have front audio connector. Also please make sure the pin assignment on the cable is the same as the pin assignment on the MB header. To find out if the chassis you are buying support front audio connector, please contact your dealer. Please note, you can have the alternative of using front audio connector or of using rear audio connector to play sound.

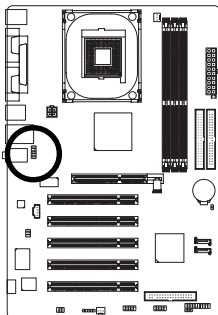

Pin No.	Definition
1	MIC
2	GND
3	MIC_BIAS
4	Power
5	Front Audio (R)
6	Rear Audio (R)
7	Reserved
8	No Pin
9	Front Audio (L)
10	Rear Audio (L)

11) SPDIF_IO (SPDIF In/Out Connector)

The SPDIF output is capable of providing digital audio to external speakers or compressed AC3 data to an external Dolby Digital Decoder. Use this feature only when your stereo system has digital input function. Be careful with the polarity of the SPDIF_IO connector. Check the pin assignment carefully while you connect the SPDIF cable, incorrect connection between the cable and connector will make the device unable to work or even damage it. For optional SPDIF cable, please contact your local dealer.

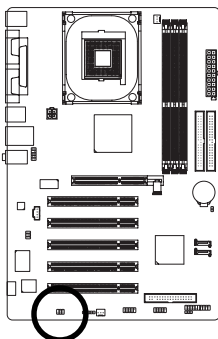

Pin No.	Definition
1	VCC
2	No Pin
3	SPDIF
4	SPDIFI
5	GND
6	GND

12) SUR_CEN (Surround Center Connector)

Please contact your nearest dealer for optional SUR_CEN cable.

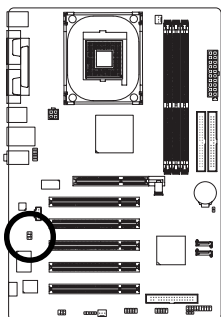

Pin No.	Definition
1	SUR OUTL
2	SUR OTR
3	GND
4	No Pin
5	CENTER_OUT
6	BASS_OUT

13) CD_IN (CD In Connector)

Connect CD-ROM or DVD-ROM audio out to the CD_IN connector

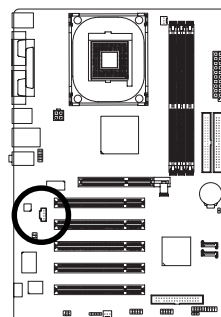

Pin No.	Definition
1	CD-L
2	GND
3	GND
4	CD-R

14) F_USB1 / F_USB2 (Front USB Connector)

Be careful with the polarity of the front USB connector. Check the pin assignment carefully while you connect the front USB cable, incorrect connection between the cable and connector will make the device unable to work or even damage it. For optional front USB cable, please contact your local dealer.

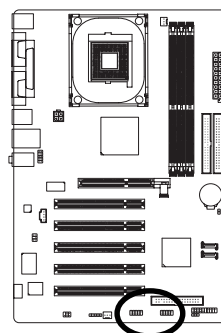

Pin No.	Definition
1	Power
2	Power
3	USB DX-
4	USB Dy-
5	USB DX+
6	USB Dy+
7	GND
8	GND
9	No Pin
10	NC

15) IR

Be careful with the polarity of the IR connector while you connect the IR. Please contact your nearest dealer for optional IR device.

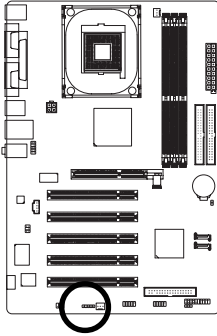

Pin No.	Definition
1	VCC
2	No Pin
3	IR RX
4	GND
5	IR TX

16) CLR_CMOS (Clear CMOS)

You may clear the CMOS data to its default values by this jumper. To clear CMOS, temporarily short 1-2 pin. Default doesn't include the "Shunter" to prevent from improper use this jumper.

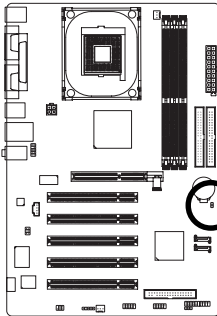

Open: Normal



Short: Clear CMOS

17) BAT (BATTERY)

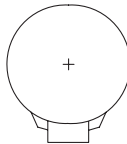
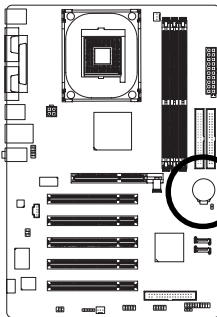

CAUTION

- ❖ Danger of explosion if battery is incorrectly replaced.
- ❖ Replace only with the same or equivalent type recommended by the manufacturer.
- ❖ Dispose of used batteries according to the manufacturer's instructions.

If you want to erase CMOS...

1. Turn OFF the computer and unplug the power cord.
2. Remove the battery, wait for 30 second.
3. Re-install the battery.
4. Plug the power cord and turn ON the computer.

Chapter 2 BIOS Setup

BIOS Setup is an overview of the BIOS Setup Program. The program that allows users to modify the basic system configuration. This type of information is stored in battery-backed CMOS RAM so that it retains the Setup information when the power is turned off.

ENTERING SETUP

Powering ON the computer and pressing immediately will allow you to enter Setup. If you require more advanced BIOS settings, please go to "Advanced BIOS" setting menu. To enter Advanced BIOS setting menu, press "Ctrl+F1" key on the BIOS screen.

CONTROL KEYS

<↑><↓><←><→>	Move to select item
<Enter>	Select Item
<Esc>	Main Menu - Quit and not save changes into CMOS Status Page Setup Menu and Option Page Setup Menu - Exit current page and return to Main Menu
<+ /PgUp>	Increase the numeric value or make changes
<- /PgDn>	Decrease the numeric value or make changes
<F1>	General help, only for Status Page Setup Menu and Option Page Setup Menu
<F2>	Item Help
<F5>	Restore the previous CMOS value from CMOS, only for Option Page Setup Menu
<F6>	Load the file-safe default CMOS value from BIOS default table
<F7>	Load the Optimized Defaults
<F8>	Q-Flash utility
<F9>	System Information
<F10>	Save all the CMOS changes, only for Main Menu

Main Menu

The on-line description of the highlighted setup function is displayed at the bottom of the screen.

Status Page Setup Menu / Option Page Setup Menu

Press F1 to pop up a small help window that describes the appropriate keys to use and the possible selections for the highlighted item. To exit the Help Window press <Esc>.

The Main Menu (For example: BIOS Ver. : E10)

Once you enter Award BIOS CMOS Setup Utility, the Main Menu (as figure below) will appear on the screen. Use arrow keys to select among the items and press <Enter> to accept or enter the sub-menu.

CMOS Setup Utility-Copyright (C) 1984-2004 Award Software

<ul style="list-style-type: none"> ▶ Standard CMOS Features ▶ Advanced BIOS Features ▶ Integrated Peripherals ▶ Power Management Setup ▶ PnP/PCI Configurations ▶ PC Health Status ▶ MB Intelligent Tweaker(M.I.T.) 	<ul style="list-style-type: none"> Top Performance Load Fail-Safe Defaults Load Optimized Defaults Set Supervisor Password Set User Password Save & Exit Setup Exit Without Saving
ESC: Quit	↑↓→←: Select Item
F8: Q-Flash	F10: Save & Exit Setup
Time, Date, Hard Disk Type...	



If you can't find the setting you want, please press "Ctrl+F1" to search the advanced option hidden.

- **Standard CMOS Features**
This setup page includes all the items in standard compatible BIOS.
- **Advanced BIOS Features**
This setup page includes all the items of Award special enhanced features.
- **Integrated Peripherals**
This setup page includes all onboard peripherals.
- **Power Management Setup**
This setup page includes all the items of Green function features.
- **PnP/PCI Configuration**
This setup page includes all the configurations of PCI & PnP ISA resources.
- **PC Health Status**
This setup page is the System auto detect Temperature, voltage, fan, speed.
- **MB Intelligent Tweaker(M.I.T.)**
This setup page is control CPU clock and frequency ratio.
- **Top Performance**
If you wish to maximize the performance of your system, set "Top Performance" as "Enabled".
- **Load Fail-Safe Defaults**
Fail-Safe Defaults indicates the value of the system parameters which the system would be in safe configuration.
- **Load Optimized Defaults**
Optimized Defaults indicates the value of the system parameters which the system would be in best performance configuration.
- **Set Supervisor Password**
Change, set, or disable password. It allows you to limit access to the system and Setup, or just to Setup.
- **Set User Password**
Change, set, or disable password. It allows you to limit access to the system.
- **Save & Exit Setup**
Save CMOS value settings to CMOS and exit setup.
- **Exit Without Saving**
Abandon all CMOS value changes and exit setup.

Standard CMOS Features

CMOS Setup Utility-Copyright (C) 1984-2004 Award Software
Standard CMOS Features

Date (mm.dd.yy)	Thu, Oct 7 2004	Item Help
Time (hh:mm:ss)	22:31:24	Menu Level▶
▶ IDE Channel 0 Master	[None]	Change the day, month, year
▶ IDE Channel 0 Slave	[None]	<Week>
▶ IDE Channel 1 Master	[None]	Sun. to Sat.
▶ IDE Channel 1 Slave	[None]	<Month>
Drive A	[1.44M, 3.5"]	Jan. to Dec.
Drive B	[None]	<Day>
Floppy 3 Mode Support	[Disabled]	1 to 31 (or maximum allowed in the month)
Halt On	[All, But Keyboard]	<Year>
Base Memory	640K	1999 to 2098
Extended Memory	127M	
Total Memory	128M	
↑↓→←: Move Enter: Select +/-/PU/PD: Value F10: Save ESC: Exit F1: General Help F5: Previous Values F6: Fail-Save Defaults F7: Optimized Defaults		

☞ Date

The date format is <week>, <month>, <day>, <year>.

- ▶▶ Week The week, from Sun to Sat, determined by the BIOS and is display only
- ▶▶ Month The month, Jan. Through Dec.
- ▶▶ Day The day, from 1 to 31 (or the maximum allowed in the month)
- ▶▶ Year The year, from 1999 through 2098

☞ Time

The times format in <hour> <minute> <second>. The time is calculated base on the 24-hour military-time clock. For example, 1 p.m. is 13:00:00.

☞ IDE Channel 0 Master, Slave / IDE Channel 1 Master, Slave

- ▶▶ IDE HDD Auto-Detection Press "Enter" to select this option for automatic device detection.
- ▶▶ IDE Channel 0 Master/Slave; IDE Channel 1 Master/Slave
SATA devices setup. You can use one of three methods:
 - Auto Allows BIOS to automatically detect IDE devices during POST. (Default value)
 - None Select this if no IDE devices are used and the system will skip the automatic detection step and allow for faster system start up.
 - Manual User can manually input the correct settings.
- ▶▶ Access Mode Use this to set the access mode for the hard drive. The four options are:
CHS/LBA/Large/Auto(default:Auto)

Hard drive information should be labeled on the outside drive casing. Enter the appropriate option based on this information.

- ▶▶ Cylinder Number of cylinders
- ▶▶ Head Number of heads
- ▶▶ Precomp Write precomp
- ▶▶ Landing Zone Landing zone
- ▶▶ Sector Number of sectors

If a hard disk has not been installed, select NONE and press <Enter>.

☞ Drive A / Drive B

The category identifies the types of floppy disk drive A or drive B that has been installed in the computer.

- ▶▶ None No floppy drive installed
- ▶▶ 360K, 5.25" 5.25 inch PC-type standard drive; 360K byte capacity.
- ▶▶ 1.2M, 5.25" 5.25 inch AT-type high-density drive; 1.2M byte capacity (3.5 inch when 3 Mode is Enabled).
- ▶▶ 720K, 3.5" 3.5 inch double-sided drive; 720K byte capacity
- ▶▶ 1.44M, 3.5" 3.5 inch double-sided drive; 1.44M byte capacity.
- ▶▶ 2.88M, 3.5" 3.5 inch double-sided drive; 2.88M byte capacity.

☞ Floppy 3 Mode Support (for Japan Area)

- ▶▶ Disabled Normal Floppy Drive. (Default value)
- ▶▶ Drive A Drive A is 3 mode Floppy Drive.
- ▶▶ Drive B Drive B is 3 mode Floppy Drive.
- ▶▶ Both Drive A & B are 3 mode Floppy Drives.

☞ Halt on

The category determines whether the computer will stop if an error is detected during power up.

- ▶▶ No Errors The system boot will not stop for any error that may be detected and you will be prompted.
- ▶▶ All Errors Whenever the BIOS detects a non-fatal error the system will be stopped.
- ▶▶ All, But Keyboard The system boot will not stop for a keyboard error; it will stop for all other errors. (Default value)
- ▶▶ All, But Diskette The system boot will not stop for a disk error; it will stop for all other errors.
- ▶▶ All, But Disk/Key The system boot will not stop for a keyboard or disk error; it will stop for all other errors.

☞ Memory

The category is display-only which is determined by POST (Power On Self Test) of the BIOS.

▶▶ Base Memory

The POST of the BIOS will determine the amount of base (or conventional) memory installed in the system.

The value of the base memory is typically 512K for systems with 512K memory installed on the motherboard, or 640K for systems with 640K or more memory installed on the motherboard.

▶▶ Extended Memory

The BIOS determines how much extended memory is present during the POST.

This is the amount of memory located above 1 MB in the CPU's memory address map.

▶▶ Total Memory

This item displays the memory size that used.

Advanced BIOS Features

CMOS Setup Utility-Copyright (C) 1984-2004 Award Software
Advanced BIOS Features

		Item Help
▶ Hard Disk Boot Priority	[Press Enter]	
First Boot Device	[Floppy]	Menu Level▶
Second Boot Device	[Hard Disk]	
Third Boot Device	[CDROM]	
Boot Up Floppy Seek	[Disabled]	Select Hard Disk Boot Device Priority
Password Check	[Setup]	
CPU Hyper-Threading *	[Enabled]	
Limit CPUID Max. to 3	[Enabled]	
Init Display First	[AGP]	

↑↓→←: Move Enter: Select +/-/PU/PD: Value F10: Save ESC: Exit F1: General Help
F5: Previous Values F6: Fail-Save Defaults F7: Optimized Defaults



" # " System will detect automatically and show up when you install the Intel® Pentium® 4 processor with HT Technology.

☞ Hard Disk Boot Priority

Select boot sequence for onboard(or add-on cards) SCSI, RAID, etc.

Use <↑> or <↓> to select a device, then press<+> to move it up, or <-> to move it down the list. Press <ESC> to exit this menu.

☞ First / Second / Third Boot Device

- ▶▶ Floppy Select your boot device priority by Floppy.
- ▶▶ LS120 Select your boot device priority by LS120.
- ▶▶ Hard Disk Select your boot device priority by Hard Disk.
- ▶▶ CDROM Select your boot device priority by CDROM.
- ▶▶ ZIP Select your boot device priority by ZIP.
- ▶▶ USB-FDD Select your boot device priority by USB-FDD.
- ▶▶ USB-ZIP Select your boot device priority by USB-ZIP.
- ▶▶ USB-CDROM Select your boot device priority by USB-CDROM.
- ▶▶ USB-HDD Select your boot device priority by USB-HDD.
- ▶▶ LAN Select your boot device priority by LAN.
- ▶▶ Disabled Select your boot device priority by Disabled.

☞ Boot Up Floppy Seek

During POST, BIOS will determine the floppy disk drive installed is 40 or 80 tracks. 360K type is 40 tracks 720K, 1.2M and 1.44M are all 80 tracks.

- ▶▶ Enabled BIOS searches for floppy disk drive to determine it is 40 or 80 tracks. Note that BIOS can not tell from 720K, 1.2M or 1.44M drive type as they are all 80 tracks.
- ▶▶ Disabled BIOS will not search for the type of floppy disk drive by track number. Note that there will not be any warning message if the drive installed is 360K.
(Default value)

☞ Password Check

- ▶▶ System The system can not boot and can not access to Setup page will be denied if the correct password is not entered at the prompt.
- ▶▶ Setup The system will boot, but access to Setup will be denied if the correct password is not entered at the prompt. (Default value)

☞ CPU Hyper-Threading

- ▶▶ Enabled Enables CPU Hyper Threading Feature. Please note that this feature is only working for operating system with multi processors mode supported. (Default value)
- ▶▶ Disabled Disables CPU Hyper Threading.

☞ Limit CUID Max. to 3

- ▶▶ Enabled Limit CUID Maximum value to 3 when use older OS like NT4. (Default value)
- ▶▶ Disabled Disables CUID Limit for Windows XP.

☞ Init Display First

Select the first initiation of monitor or display from AGP or PCI VGA card.

- ▶▶ AGP Set Init display first to AGP. (Default value)
- ▶▶ PCI Set Init display first to PCI.

Integrated Peripherals

CMOS Setup Utility-Copyright (C) 1984-2004 Award Software
Integrated Peripherals

		Item Help
IDE1 Conductor Cable	[Auto]	
IDE2 Conductor Cable	[Auto]	Menu Level▶
On-Chip Primary PCI IDE	[Enabled]	
On-Chip Secondary PCI IDE	[Enabled]	
AC97 Audio	[Enabled]	
Onboard LAN device *	[Enabled]	[Auto] Auto-detect IDE cable type
USB Controller	[Enabled]	
USB Legacy Support	[Disabled]	
SiS Serial ATA Controller	[Enabled]	[ATA66/100/133] Set Conductor cable to ATA66/100/133(80 Pins)
SiS Serial ATA Mode	[RAID]	
Onboard Serial Port 1	[3F8/IRQ4]	
Onboard Serial Port 2	[2F8/IRQ3]	
Onboard Parallel Port	[378/IRQ7]	
Parallel Port Mode	[ECP]	[ATA33] Set Conductor cable to ATA33(40-Pins)
ECP Mode Use DMA	[3]	

↑↓→←: Move Enter: Select +/-/PU/PD: Value F10: Save ESC: Exit F1: General Help
 F5: Previous Values F6: Fail-Save Defaults F7: Optimized Defaults

☞ IDE1 Conductor Cable

- ▶▶ Auto Will be automatically detected by BIOS. (Default value)
- ▶▶ ATA66/100/133 Set IDE1 Conductor Cable to ATA66/100/133 (Please make sure your IDE device and cable is compatible with ATA66/100/133).
- ▶▶ ATA33 Set IDE1 Conductor Cable to ATA33 (Please make sure your IDE device and cable is compatible with ATA33).

☞ IDE2 Conductor Cable

- ▶▶ Auto Will be automatically detected by BIOS. (Default value)
- ▶▶ ATA66/100/133 Set IDE2 Conductor Cable to ATA66/100/133 (Please make sure your IDE device and cable is compatible with ATA66/100/133).
- ▶▶ ATA33 Set IDE2 Conductor Cable to ATA33 (Please make sure your IDE device and cable is compatible with ATA33).

☞ On-Chip Primary PCI IDE

- ▶▶ Enabled Enable onboard 1st channel IDE port. (Default value)
- ▶▶ Disabled Disable onboard 1st channel IDE port.

☞ On-Chip Secondary PCI IDE

- ▶▶ Enabled Enable onboard 2nd channel IDE port. (Default value)
- ▶▶ Disabled Disable onboard 2nd channel IDE port.

☞ AC97 Audio

- ▶▶ Enabled Enable onboard AC'97 audio function. (Default value)
- ▶▶ Disabled Disable this function.

☞ Onboard LAN device *

- ▶▶ Disabled Disable this function.
- ▶▶ Enabled Enable Onboard Lan Chip device. (Default value)

*** Only for 8S648FXP-RZ.

☞ **USB Controller**

- ▶▶ Enabled Enable USB Controller. (Default value)
- ▶▶ Disabled Disable USB Controller.

☞ **USB Legacy Support**

When USB keyboard or mouse is installed, please set at Enabled.

- ▶▶ Enabled Enable USB keyboard or mouse support.
- ▶▶ Disabled Disable USB keyboard or mouse support. (Default value)

☞ **SiS Serial ATA Controller**

- ▶▶ Enabled Enable onboard SiS serial ATA Controller. (Default value)
- ▶▶ Disabled Disable this function.

☞ **SiS Serial ATA Mode**

- ▶▶ IDE Set onboard Serial ATA function as IDE.
- ▶▶ RAID Set onboard Serial ATA function as RAID. (Default value)

☞ **Onboard Serial Port 1**

- ▶▶ Auto BIOS will automatically setup the port 1 address.
- ▶▶ 3F8/IRQ4 Enable onboard Serial port 1 and address is 3F8. (Default value)
- ▶▶ 2F8/IRQ3 Enable onboard Serial port 1 and address is 2F8.
- ▶▶ 3E8/IRQ4 Enable onboard Serial port 1 and address is 3E8.
- ▶▶ 2E8/IRQ3 Enable onboard Serial port 1 and address is 2E8.
- ▶▶ Disabled Disable onboard Serial port 1.

☞ **Onboard Serial Port 2**

- ▶▶ Auto BIOS will automatically setup the port 2 address.
- ▶▶ 3F8/IRQ4 Enable onboard Serial port 2 and address is 3F8.
- ▶▶ 2F8/IRQ3 Enable onboard Serial port 2 and address is 2F8. (Default value)
- ▶▶ 3E8/IRQ4 Enable onboard Serial port 2 and address is 3E8.
- ▶▶ 2E8/IRQ3 Enable onboard Serial port 2 and address is 2E8.
- ▶▶ Disabled Disable onboard Serial port 2.

☞ **Onboard Parallel port**

- ▶▶ Disabled Disable onboard LPT port.
- ▶▶ 378/IRQ7 Enable onboard LPT port and address is 378/IRQ7. (Default value)
- ▶▶ 278/IRQ5 Enable onboard LPT port and address is 278/IRQ5.
- ▶▶ 3BC/IRQ7 Enable onboard LPT port and address is 3BC/IRQ7.

☞ **Parallel Port Mode**

- ▶▶ SPP Using Parallel port as Standard Parallel Port.
- ▶▶ EPP Using Parallel port as Enhanced Parallel Port.
- ▶▶ ECP Using Parallel port as Extended Capabilities Port. (Default value)
- ▶▶ ECP+EPP Using Parallel port as ECP & EPP mode.

☞ **ECP Mode Use DMA**

- ▶▶ 3 Set ECP Mode Use DMA to 3. (Default value)
- ▶▶ 1 Set ECP Mode Use DMA to 1.

Power Management Setup

CMOS Setup Utility-Copyright (C) 1984-2004 Award Software
Power Management Setup

		Item Help
ACPI Suspend Type	[S1(POS)]	Menu Level▶
Soft-Off by PWR_BTTN	[Off]	
System After AC Back	[Off]	
IRQ [3-7, 9-15], NMI	[Enabled]	[S1]
ModemRingOn	[Enabled]	Set suspend type to
PME Event Wake Up	[Enabled]	Power On Suspend under
Power On by Keyboard	[Disabled]	ACPI OS
Power On by Mouse	[Disabled]	
Resume by Alarm	[Disabled]	[S3]
x Month Alarm	NA	Set suspend type to
x Day (of Month)	Everyday	Suspend to RAM under
x Time (hh:mm:ss)	0 : 0 : 0	ACPI OS
Power LED in S1 state	[Blinking]	

↑↓←→: Move Enter: Select +/-/PU/PD: Value F10: Save ESC: Exit F1: General Help
 F5: Previous Values F6: Fail-Save Defaults F7: Optimized Defaults

ACPI Suspend Type

- ▶▶ S1(POS) Set ACPI suspend type to S1. (Default value)
- ▶▶ S3(STR) Set ACPI suspend type to S3.

Soft-Off by PWR_BTTN

- ▶▶ Off The user press the power button once, he can turn off the system.
(Default value)
- ▶▶ Suspend The user press the power button once, then he can enter suspend mode.

System After AC Back

- ▶▶ Laststate When AC-power back to the system, the system will return to the Last state
before AC-power off.
- ▶▶ Off When AC-power back to the system, the system will be in "Off" state.
(Default value)
- ▶▶ On When AC-power back to the system, the system will be in "On" state.

IRQ [3-7, 9-15], NMI

When IRQ [3-7, 9-15] or NMI triggered, the suspend timer will be reloaded to prevent system gets into green mode.

- ▶▶ Disabled Don't monitor IRQ [3-7, 9-15] or NMI.
- ▶▶ Enabled Monitor IRQ [3-7, 9-15] or NMI. (Default value)

ModemRingOn

- ▶▶ Disabled Disable Modem Ring on function.
- ▶▶ Enabled Enable Modem Ring on function. (Default value)

PME Event Wake Up

- ▶▶ Disabled Disable this function.
- ▶▶ Enabled Enable PME as wake up event. (Default value)

☞ Power On by Keyboard

- ▶▶ Any Key Set keyboard power on by any key.
- ▶▶ Password Enter from 1 to 8 characters to set the keyboard power on password.
- ▶▶ Disabled Disabled this function. (Default value)

☞ Power On by Mouse

- ▶▶ Enabled Power on system by move or click the mouse.
- ▶▶ Disabled Disable this function. (Default value)

☞ Resume by Alarm

You can set "Resume by Alarm" item to enabled and key in Date/time to power on system.

- ▶▶ Disabled Disable this function. (Default value)
- ▶▶ Enabled Enable alarm function to POWER ON system.

If RTC Alarm Lead To Power On is Enabled.

Month Alarm : NA, 1~12

Day (of Month) : Everyday, 1~31

Time (hh: mm: ss) : (0~23) : (0~59) : (0~59)

☞ Power LED in S1 state

- ▶▶ Blinking In standby mode(S1), power LED will blink. (Default value)
- ▶▶ Dual/OFF In standby mode(S1):
 - a. If use single color LED, power LED will turn off.
 - b. If use dual color LED, power LED will turn to another color.

PnP/PCI Configurations

CMOS Setup Utility-Copyright (C) 1984-2004 Award Software
PnP/PCI Configurations

		Item Help
PCI 4 IRQ Assignment	[Auto]	Menu Level▶ Device(s) using this INT: Display Cntrlr - Bus 1 Dev 0 Func 0
PCI 1/5 IRQ Assignment	[Auto]	
PCI 2 IRQ Assignment	[Auto]	
PCI 3 IRQ Assignment	[Auto]	
↑↓→←: Move Enter: Select +/-/PU/PD: Value F10: Save ESC: Exit F1: General Help F5: Previous Values F6: Fail-Save Defaults F7: Optimized Defaults		

☞ PCI 4 IRQ Assignment

- ▶▶ Auto Auto assign IRQ to PCI 4. (Default value)
- ▶▶ 3,4,5,7,9,10,11,12,14,15 Set IRQ 3,4,5,7,9,10,11,12,14,15 to PCI 4.

☞ PCI 1/PCI 5 IRQ Assignment

- ▶▶ Auto Auto assign IRQ to PCI 1/PCI 5. (Default value)
- ▶▶ 3,4,5,7,9,10,11,12,14,15 Set IRQ 3,4,5,7,9,10,11,12,14,15 to PCI 1/PCI 5.

☞ PCI 2 IRQ Assignment

- ▶▶ Auto Auto assign IRQ to PCI 2. (Default value)
- ▶▶ 3,4,5,7,9,10,11,12,14,15 Set IRQ 3,4,5,7,9,10,11,12,14,15 to PCI 2.

☞ PCI 3 IRQ Assignment

- ▶▶ Auto Auto assign IRQ to PCI 3. (Default value)
- ▶▶ 3,4,5,7,9,10,11,12,14,15 Set IRQ 3,4,5,7,9,10,11,12,14,15 to PCI 3.

PC Health Status

CMOS Setup Utility-Copyright (C) 1984-2004 Award Software
PC Health Status

Vcore	OK	Item Help
DDR2.5V	OK	Menu Level▶
+3.3V	OK	
+12V	OK	
Current CPU Temperature	41°C	
Current CPU FAN Speed	4440 RPM	
Current SYSTEM FAN Speed	0 RPM	
↑↓→←: Move Enter: Select +/-/PU/PD: Value F10: Save ESC: Exit F1: General Help F5: Previous Values F6: Fail-Save Defaults F7: Optimized Defaults		

- ☞ **Current Voltage (V) Vcore / DDR2.5V / +3.3V / +12V**
▶▶ Detect system's voltage status automatically.
- ☞ **Current CPU Temperature**
▶▶ Detect CPU temperature automatically.
- ☞ **Current CPU/SYSTEM FAN Speed (RPM)**
▶▶ Detect CPU/SYSTEM Fan speed status automatically.

MB Intelligent Tweaker(M.I.T.)

CMOS Setup Utility-Copyright (C) 1984-2004 Award Software
MB Intelligent Tweaker(M.I.T.)

		Item Help
Configure DRAM Timing	[Auto]	Menu Level▶
x CAS Latency Setting	2.5T	
x DRAM RAS Active Time	9T	
x DRAM RAS Precharge Time	5T	
x DRAM RAS to CAS Delay	5T	
CPU Clock Ratio	[21X]	[AUTO] Configure DRAM Timing automatically
Linear Frequency Control	[Disabled]	
x CPU Clock (MHz)	133	[Manual] Configure DRAM Timing by manual
x DRAM Clock (MHz)	AUTO	
AGP/PCI Clock Control	[AUTO]	
x AGP Clock (MHz)	66	
x PCI Clock (MHz)	33	
DRAM Voltage Control	[Normal]	Warning: Wrong DRAM Timing may make system can't boot. Clear CMOS to overcome wrong Timing issue.

↑↓←→: Move Enter: Select +/-/PU/PD: Value F10: Save ESC: Exit F1: General Help
 F5: Previous Values F6: Fail-Save Defaults F7: Optimized Defaults



CAUTION

Incorrect using these features may cause your system broken. For power end-user use only.

☞ Configure DRAM Timing

- ▶▶ Auto Configure the DRAM Timing automatically. (Default value)
- ▶▶ Manual Configure the DRAM Timing manually.

☞ CAS Latency Setting

- ▶▶ Set CAS Latency manually. Options are: 2T, 2.5T, 3T, and Auto. (Default value: 2.5T)

☞ DRAM RAS Active Time

- ▶▶ Set DRAM RAS Active Time manually. Options are: 6T, 7T, 5T, 4T, 8T and 9T. (Default value: 9T)

☞ DRAM RAS Precharge Time

- ▶▶ Set DRAM RAS Precharge Time manually. Options are: 3T, 2T, 4T, and 5T. (Default value:5T)

☞ DRAM RAS to CAS Delay

- ▶▶ Set DRAM RAS to CAS Delay Time manually. Options are: 3T, 2T, 4T, and 5T. (Default value:5T)

☞ CPU Clock Ratio

- This setup option will automatically assign by CPU detection.
- The option will display "Locked" and read only if the CPU ratio is not changeable.

☞ Linear Frequency Control

- ▶▶ Disabled Disable this function. (Default value)
- ▶▶ Enabled Enable this function.

☞ CPU Clock (MHz)

- ▶▶ 100MHz ~ 355MHz Set CPU Host Clock from 100MHz to 355MHz.
- If you use a 400MHz FSB Pentium 4 processor, please set "CPU Clock" to **100MHz**. If you use a 533 MHz FSB Pentium 4 processor, please set "CPU Clock" to **133MHz**. If you use a 800MHz FSB Pentium 4 processor, please set "CPU Clock" to **200MHz**.

☞ DRAM Clock (MHz)

▶▶ Please set DRAM Clock according to your requirement.
If you use the DDR266 DRAM module, please set "DRAM Clock(MHz)" to **Auto** or **266**. If you use the DDR333 DRAM module, please set "DRAM Clock(MHz)" to **Auto** or **333**. If you use the DDR400 DRAM module, please set "DRAM Clock(MHz)" to **Auto** or **400**.

☞ AGP/PCI Clock Control

▶▶ AUTO Set AGP/PCI Clock Control to AUTO. (Default value)
▶▶ Manual Set AGP/PCI Clock Control to Manual.

☞ AGP Clock (MHz)

▶▶ Please set AGP Clock according to your requirement.

☞ PCI Clock (MHz)

▶▶ Please set PCI Clock according to your requirement.

☞ DRAM Voltage Control

▶▶ Normal Set DRAM Voltage Control to Normal. (Default value)
▶▶ +0.1V Set DRAM Voltage Control to +0.1V.

Top Performance

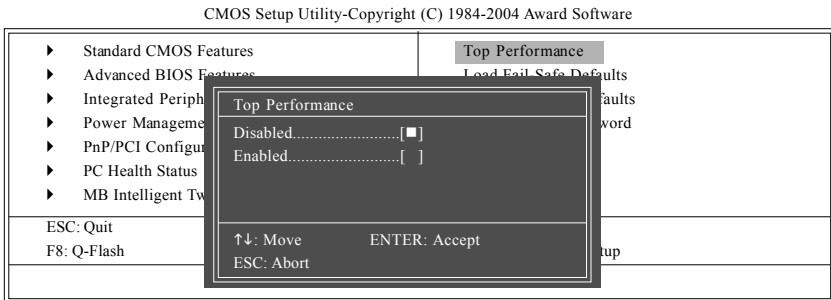

If you wish to maximize the performance of your system, set "Top Performance" as "Enabled".

▶▶ Disabled Disable this function. (Default Value)
▶▶ Enabled Enable Top Performance function.

⚠* "Top Performance" will increase H/W working speed. Different system configuration (both H/W component and OS) will effect the result. For example, the same H/W configuration might not run properly with Windows XP, but works smoothly with Windows NT. Therefore, if your system is not perform enough, the reliability or stability problem will appear sometimes, and we will recommend you disabling the option to avoid the problem as mentioned above.

Load Fail-Safe Defaults

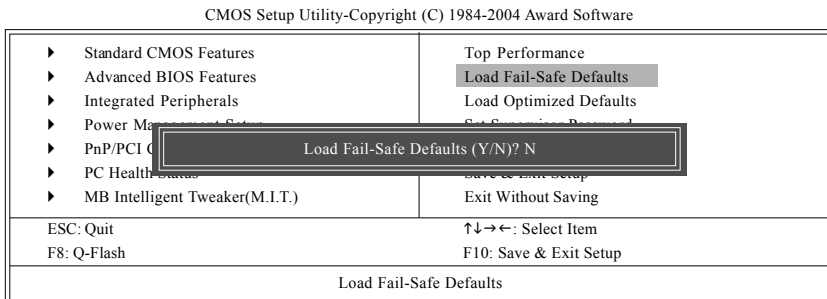

Fail-Safe defaults contain the most appropriate values of the system parameters that allow minimum system performance.

Load Optimized Defaults

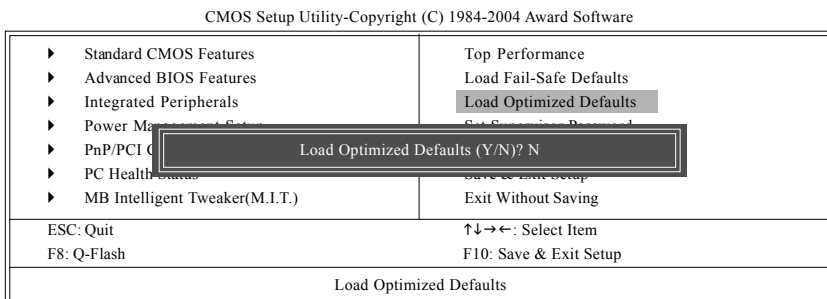

Selecting this field loads the factory defaults for BIOS and Chipset Features which the system automatically detects.

Set Supervisor/User Password

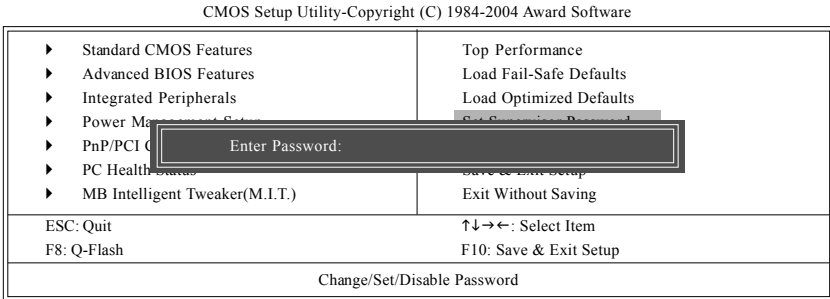

When you select this function, the following message will appear at the center of the screen to assist you in creating a password.

Type the password, up to eight characters, and press <Enter>. You will be asked to confirm the password. Type the password again and press <Enter>. You may also press <Esc> to abort the selection and not enter a password.

To disable password, just press <Enter> when you are prompted to enter password. A message "PASSWORD DISABLED" will appear to confirm the password being disabled. Once the password is disabled, the system will boot and you can enter Setup freely.

The BIOS Setup program allows you to specify two separate passwords:

SUPERVISOR PASSWORD and a USER PASSWORD. When disabled, anyone may access all BIOS Setup program function. When enabled, the Supervisor password is required for entering the BIOS Setup program and having full configuration fields, the User password is required to access only basic items.

If you select "System" at "Password Check" in Advance BIOS Features Menu, you will be prompted for the password every time the system is rebooted or any time you try to enter Setup Menu.

If you select "Setup" at "Password Check" in Advance BIOS Features Menu, you will be prompted only when you try to enter Setup.

Save & Exit Setup

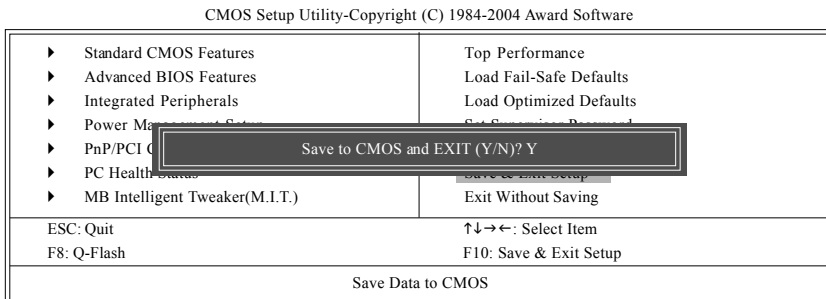

Type "Y" will quit the Setup Utility and save the user setup value to RTC CMOS.
Type "N" will return to Setup Utility.

Exit Without Saving

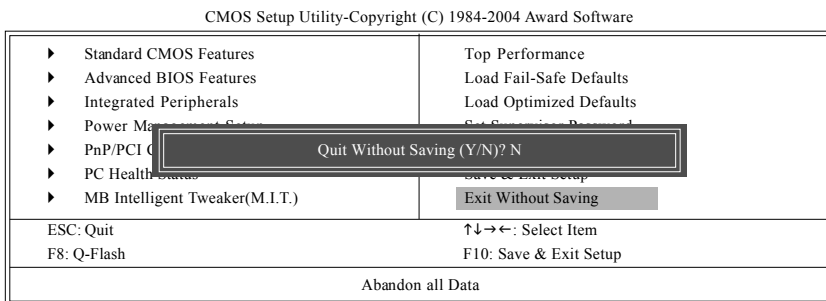

Type "Y" will quit the Setup Utility without saving to RTC CMOS.
Type "N" will return to Setup Utility.

Chapter 3 Install Drivers

Install Drivers



Pictures below are shown in Windows XP

Insert the driver CD-title that came with your motherboard into your CD-ROM drive, the driver CD-title will auto start and show the installation guide. If not, please double click the CD-ROM device icon in "My computer", and execute the setup.exe.

INSTALL CHIPSET DRIVER

After insert the driver CD, "Xpress Install" will scan automatically the system and then list all the drivers that recommended to install. The "Xpress Install" uses the "Click and Go" technology to install the drivers automatically. Just select the drivers you want then click the "GO" button. The "Xpress Install" will execute the installation for you automatically.

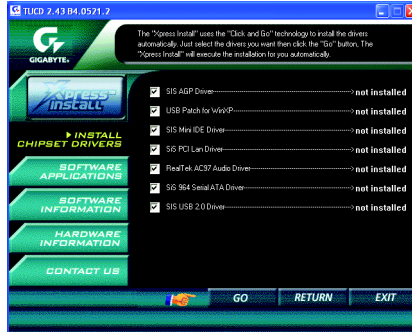

Some device drivers will restart your system automatically. After restarting your system the "Xpress Install" will continue to install other drivers.

System will reboot automatically after install the drivers, afterward you can install others application.



For USB2.0 driver support under Windows XP operating system, please use Windows Service Pack. After install Windows Service Pack, it will show a question mark "?" in "Universal Serial Bus controller" under "Device Manager". Please remove the question mark and restart the system (System will auto-detect the right USB2.0 driver).



Driver installation finished!
You have to reboot system!

Item Description

- SIS AGP Driver
AGP interface driver for SiS series chipset.
- USB Patch for WinXP
This patch driver can help you to resolve the USB device wake up S3 hang up issue in XP.
- SIS Mini IDE Driver
SiS IDE controller driver.
- SiS PCI Lan Driver *
For SiS series Lan driver.
- RealTek AC97 Audio Driver
Audio driver for Realtek AC97 codec chipset.
- SiS 964 Serial ATA Driver
Serial ATA driver for SiS964 South Bridge.
- SIS USB 2.0 Driver
USB2.0 driver for SiS series chipset.

*** Only for 8S648FXP-RZ.



Contact Us

- **Taiwan (Headquarters)**

GIGA-BYTE TECHNOLOGY CO., LTD.

Address: No.6, Bau Chiang Road, Hsin-Tien, Taipei Hsien, Taiwan.

TEL: +886 (2) 8912-4888

FAX: +886 (2) 8912-4003

Tech. Support :

<http://tw.giga-byte.com/TechSupport/ServiceCenter.htm>

Non-Tech. Support(Sales/Marketing) :

<http://ggts.gigabyte.com.tw/nontech.asp>

WEB address (English): <http://www.gigabyte.com.tw>

WEB address (Chinese): <http://chinese.giga-byte.com>

- **U.S.A.**

G.B.T. INC.

Address: 17358 Railroad St, City of Industry, CA 91748.

TEL: +1 (626) 854-9338

FAX: +1 (626) 854-9339

Tech. Support :

<http://www.giga-byte.com/TechSupport/ServiceCenter.htm>

Non-Tech. Support(Sales/Marketing) :

<http://ggts.gigabyte.com.tw/nontech.asp>

WEB address : <http://www.giga-byte.com>

- **Germany**

G.B.T. TECHNOLOGY TRADING GMBH

Address: Friedrich-Ebert-Damm 112 22047 Hamburg Deutschland

TEL: +49-40-2533040 (Sales)

+49-1803-428468 (Tech.)

FAX: +49-40-25492343 (Sales)

+49-1803-428329 (Tech.)

Tech. Support :

<http://de.giga-byte.com/TechSupport/ServiceCenter.htm>

Non-Tech. Support(Sales/Marketing) :

<http://ggts.gigabyte.com.tw/nontech.asp>

WEB address : <http://www.gigabyte.de>

- **Japan**

NIPPON GIGA-BYTE CORPORATION

WEB address : <http://www.gigabyte.co.jp>

- **Singapore**

GIGA-BYTE SINGAPORE PTE. LTD.

Tech. Support :

<http://tw.giga-byte.com/TechSupport/ServiceCenter.htm>

Non-Tech. Support(Sales/Marketing) :

<http://ggts.gigabyte.com.tw/nontech.asp>

- **U.K.**

G.B.T. TECH. CO., LTD.

Address: GUnit 13 Avant Business Centre 3 Third Avenue, Denbigh West Blechley Milton Keynes, MK1 1DR, UK, England

TEL: +44-1908-362700

FAX: +44-1908-362709

Tech. Support :

<http://uk.giga-byte.com/TechSupport/ServiceCenter.htm>

Non-Tech. Support(Sales/Marketing) :

<http://ggts.gigabyte.com.tw/nontech.asp>

WEB address : <http://uk.giga-byte.com>

- **The Netherlands**

GIGA-BYTE TECHNOLOGY B.V.

TEL: +31 40 290 2088

NL Tech.Support: 0900-GIGABYTE (0900-44422983)

BE Tech.Support: 0900-84034

FAX: +31 40 290 2089

Tech. Support :

<http://nz.giga-byte.com/TechSupport/ServiceCenter.htm>

Non-Tech. Support(Sales/Marketing) :

<http://ggts.gigabyte.com.tw/nontech.asp>

WEB address : <http://www.giga-byte.nl>

- **China**

NINGBO G.B.T. TECH. TRADING CO., LTD.

Tech. Support :

<http://cn.giga-byte.com/TechSupport/ServiceCenter.htm>

Non-Tech. Support(Sales/Marketing) :

<http://ggts.gigabyte.com.tw/nontech.asp>

WEB address : <http://www.gigabyte.com.cn>

Shanghai

TEL: +86-021-63410999

FAX: +86-021-63410100

Beijing

TEL: +86-010-82886651

FAX: +86-010-82888013

Wuhan

TEL: +86-027-87851061

FAX: +86-027-87851330

GuangZhou

TEL: +86-020-87586074

FAX: +86-020-85517843

Chengdu

TEL: +86-028-85236930

FAX: +86-028-85256822

Xian

TEL: +86-029-85531943

FAX: +86-029-85539821

Shenyang

TEL: +86-024-23960918

FAX: +86-024-23960918-809

- **Australia**

GIGABYTE TECHNOLOGY PTY. LTD.

Address: 3/6 Garden Road, Clayton, VIC 3168 Australia

TEL: +61 3 85616288

FAX: +61 3 85616222

Tech. Support :

<http://www.giga-byte.com.au/TechSupport/ServiceCenter.htm>

Non-Tech. Support(Sales/Marketing) :

<http://ggts.gigabyte.com.tw/nontech.asp>

WEB address : <http://www.giga-byte.com.au>

- **France**

GIGABYTE TECHNOLOGY FRANCES S.A.R.L.

Tech. Support :

<http://tw.giga-byte.com/TechSupport/ServiceCenter.htm>

Non-Tech. Support(Sales/Marketing) :

<http://ggts.gigabyte.com.tw/nontech.asp>

WEB address : <http://www.gigabyte.fr>

- **Russia**

Moscow Representative Office Of Giga-Byte Technology Co., Ltd.

Tech. Support :

<http://tw.giga-byte.com/TechSupport/ServiceCenter.htm>

Non-Tech. Support(Sales/Marketing) :

<http://ggts.gigabyte.com.tw/nontech.asp>

WEB address : <http://www.gigabyte.ru>

- **Poland**

Representative Office Of Giga-Byte Technology Co., Ltd.

POLAND

Tech. Support :

<http://tw.giga-byte.com/TechSupport/ServiceCenter.htm>

Non-Tech. Support(Sales/Marketing) :

<http://ggts.gigabyte.com.tw/nontech.asp>

WEB address : <http://www.gigabyte.pl>
